

Technical Information

HM 160.38 Underwater Weir

HM 160.38 UNDERWATER WEIR

All Rights Reserved G.U.N.T. Gerätebau GmbH, Barsbüttel, Germany 06/2004

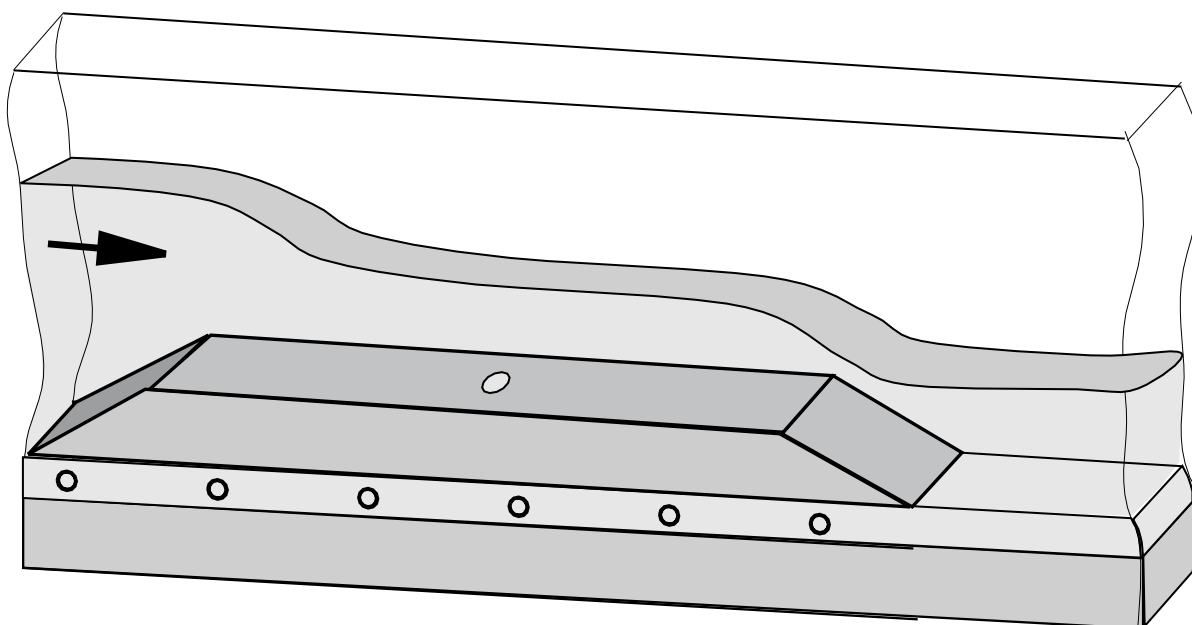

Technical Information

Please read and follow the safety regulations before the first installation!

Table of Contents

1	Introduction	1
2	Description of the unit	2
2.1	Components	2
2.2	Assembly.	2
3	Safety	3
3.1	Hazards to the unit and its function	3
4	Theory.	4
4.1	Flow processes when moving water	4
4.2	Flows in a rectangular flume: Specific energy and specific flow	6
4.3	Wide crested weir	11
5	Appendix	14
5.1	Technical data.	14
5.2	Symbols and abbreviations in formulae.	14
5.3	References	15
5.4	Items Supplied.	15

HM 160.38 *UNDERWATER WEIR*

1 Introduction

The HM 160.38 underwater weir unit is a wide crested weir for illustrating hydraulic relationships.

The unit is made of robust plastic. It is designed for installation in the HM 160 laboratory flow channel, where it can easily be secured.

The wide crested weir enables reproducible experiments that are both qualitative and quantitative in nature to be performed.

The following topics can be addressed using the crump weir:

- Flow processes in a wide crested weir
- Critical water depth
- Critical flow conditions
- Flow control
- Influence of the weir on the potential and kinetic energy of the flowing medium
- Influence on the energy level
- Beginning and effects of damming

HM 160.38 UNDERWATER WEIR

2 Description of the unit

The HM 160.38 wide crested weir unit is made of robust plastic and can easily be installed in the HM 160 laboratory flow channel using a screw.

2.1 Components

The wide crested weir is made up of the following individual parts:

- Weir body (1) with flanks that rise at an angle of 30°.
- Hexagon socket screw M6 (2) with plain washer

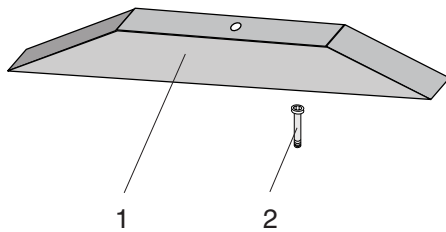

Fig. 2.1 Underwater weir

2.2 Assembly

Insert underwater weir (1) in flow channel (3) and attach to the base of the channel with the hexagon socket screw M6 (2).

The weir can be secured at various positions.

Caution! Do not assemble while water is flowing, to prevent the screws and small parts being carried away by the flow.

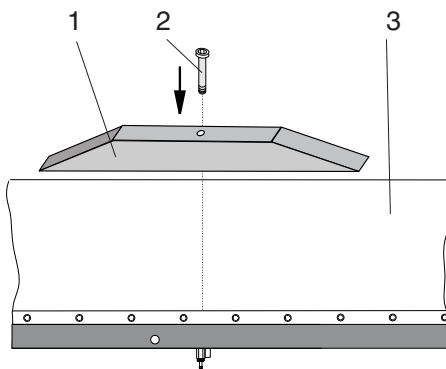

Fig. 2.2 Underwater weir assembly

HM 160.38 *UNDERWATER WEIR*

3 Safety

3.1 Hazards to the unit and its function



CAUTION! Do not leave any tools in the flow channel after assembly. They will be picked up by the flow and may get into the pump.



CAUTION! Do not carry out assembly or dismantling while water is flowing! There is a risk that bolts etc. may be caught up by the flow and get into the pump.

4 Theory

The wide crested weir comes under the category of control structures. Control structures are structural measures in a flume that set, i.e. control, the local flow. They achieve this through significant changes of cross-section (e.g. constrictions, height changes) and they are often, but not always, based on the critical flow principle.

4.1 Flow processes when moving water

A distinction is made between two basic types of movement of water:

- Flow and
- Supercritical flow

With a **flow**, the flow speed of the water v_{Water} is always less than the wave speed. This means that in a flowing section the water flows more slowly than a wave can propagate.

The wave speed v_{Wave} is generally known to only be dependent on acceleration due to gravity g and the water depth h , subject to the limitation that the interference wave from equation (1) is what is known as a shallow water wave (i.e. the wavelength is greater than the water depth).

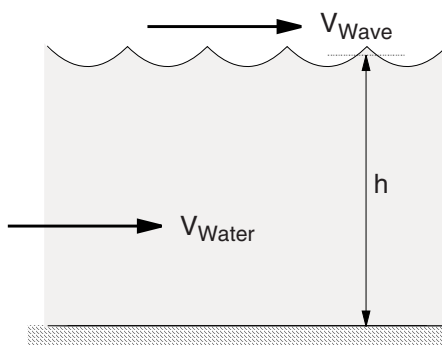

Fig. 4.1 Wave speed in shallow water

$$v_{\text{Wave}} = \sqrt{g \cdot h} \quad (1)$$

With a **supercritical flow**, the conditions are directly reversed: The wave speed is always smaller than the flow speed of the water. This means that in this case the wave can never move upstream, only downstream. This is an extremely important fact in hydraulic engineering.

HM 160.38 UNDERWATER WEIR

The point at which the wave speed is exactly equal to the flow speed is known as the **critical flow speed**.

For the critical flow speed:

$$Fr = \frac{V}{c} = \frac{V}{\sqrt{g \cdot h}} = 1 \tag{2}$$

c: Wave speed (V_{Wave})

V: Flow speed

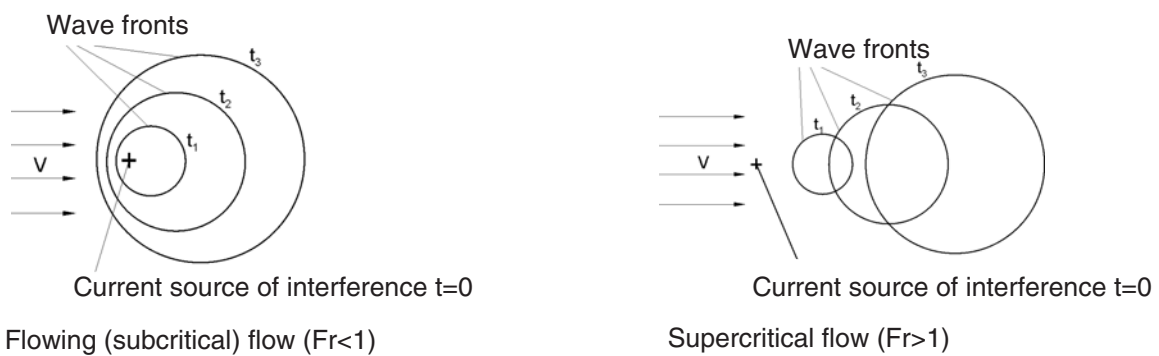

Fig. 4.2 Successive wave fronts created by a current source of interference (top view)

HM 160.38 UNDERWATER WEIR**4.2 Flows in a rectangular flume: Specific energy and specific flow**

Fig. 4.3 Flume flow in rectangular profile

The importance of specific energy is outlined below for the simplest case of a rectangular flume of width B (see Fig. 4.3) in which there is a flow Q . The flow q per unit of width, also known as the specific flow is

$$q = \frac{Q}{B} \quad (3)$$

The average speed is given by:

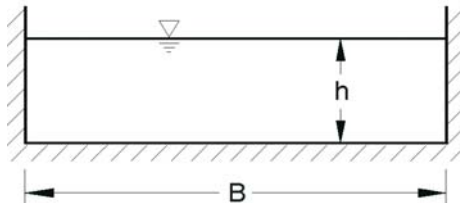
$$V = \frac{q}{h}, \quad (4)$$

which combines with the equation for the specific energy E .

$$E = y + \frac{V^2}{2 \cdot g} \quad (5)$$

[Specific energy is the level of energy measured relative to the local base position. It is an important variable that determines the behaviour of the flow in relation to local changes in geometry (e.g. base position, width).]

According to the equation:

$$E = h + \frac{q^2}{2 \cdot g \cdot h^2} \quad (6)$$

Equation (6) can be rearranged to give:

$$h^3 - E \cdot h^2 + \frac{q^2}{2 \cdot g} = 0 \quad (7)$$

This is a 3rd order equation for the water depth, which in functional terms can be stated as:

HM 160.38 UNDERWATER WEIR

$$h = f(E, q) \quad (8)$$

In other words, the local water depth is a function of the local specific energy and the specific flow. The hydraulic significance of equation (7) is considered in two ways below:

1. Given specific flow, $q = \text{Const.}$:

In general, equation (7) has two positive solutions for the water depth h , as shown in the energy diagram (Fig. 4.4) as a function of the specific energy E . For a particular value of E , there are thus two possible water depths for the flow, h_1 and h_2 .

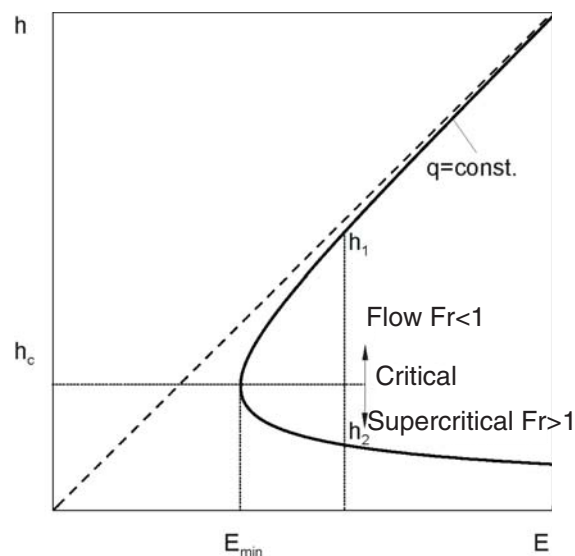

Fig. 4.4 Energy diagram: Water depth h as a function of specific energy E with a given specific flow $q = \text{Const.}$

If E is reduced, at a minimum value E_{\min} the two solutions merge, resulting in a limit value for the water depth y_c .

HM 160.38 UNDERWATER WEIR

This minimum value is given by setting the derivative from equation (6)

$$\frac{dE}{dh} = 1 - \frac{q^2}{g \cdot h^3} \quad (9)$$

equal to zero, i.e. $dE/dh = 0$,
which gives:

$$\frac{q^2}{g \cdot h_c^3} = 1 \quad (10)$$

h_c is known as the critical water depth (or depth limit)

$$h_c = \left(\frac{q^2}{g} \right)^{\frac{1}{3}} \quad (11)$$

With a given flow $q = V_h = V_c h_c$, this water depth corresponds to a critical speed V_c . If $V_c h_c$ is used for q in equation (10), this gives

$$\frac{V_c^2}{g \cdot h_c} = Fr_c^2 = 1 \quad (12)$$

In other words, the critical flow condition is characterised by a Froude number $Fr = 1.0$. If equation (10) is then used in equation (6), the minimum specific energy can be obtained:

$$E_{min} = h_c + \frac{1}{2} h_c = \frac{3}{2} h_c \quad (13)$$

This means that at the critical flow condition, two thirds (h_c) of the local energy is present as potential energy and one third ($1/2 h_c$) as kinetic energy.

The upper branch of the energy diagram, $h = h_1 > h_c$, is thus characterised by Froude numbers $Fr < 1.0$,

HM 160.38 UNDERWATER WEIR

$$\frac{q^2}{g \cdot h^3} = Fr^2 < 1 \quad (14)$$

(see equation (10)) and represents flowing conditions. Here, the flow proceeds with a significant depth (large proportion of potential energy) and a slow speed (small proportion of kinetic energy).

For the lower branch, $h=h_2 < h_c$:

$$Fr^2 > 1 \quad (15)$$

In other words, in this case supercritical flow conditions are prevalent, with a low depth and a high speed. The two corresponding flow depths h_1 and h_2 are known as alternating depths.

2. Given specific energy, $E = \text{Const.}$:

If h is plotted as a function of the specific flow q , this gives the flow parabola (Fig. 4.5).

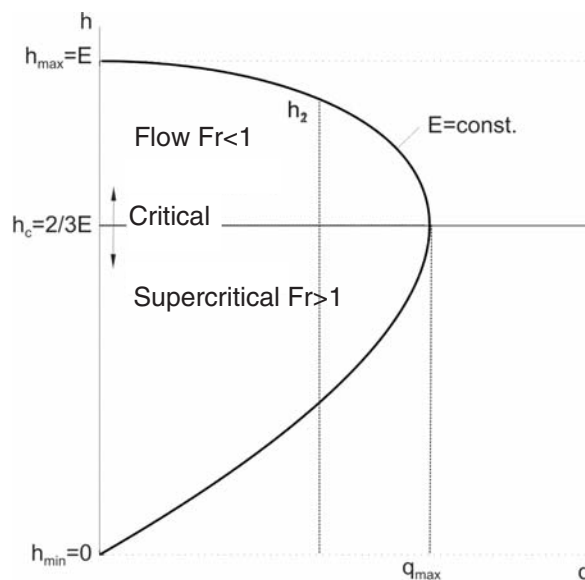

Fig. 4.5 Flow parabola: Water depth h as a function of specific flow q with a given specific energy $E = \text{Const.}$

HM 160.38 **UNDERWATER WEIR**

For a particular value of q , the two alternating depths h_1 (flow) and h_2 (supercritical flow) are possible. The maximum value for the water depth, $h_{\max} = E$, corresponds to stationary waters (with no kinetic energy). By contrast, the minimum value $h_{\min} = 0$ corresponds to a very thin, fast flowing layer with no potential energy.

The maximum flow q_{\max} is equal to the flow under critical conditions q_c and can either be found as the extreme value or is given directly by the two above equations.

$$q_c = q_{\max} = V_c h_c = \sqrt{g \cdot \left(\frac{2}{3} \cdot E\right)^3} \quad (16)$$

HM 160.38 UNDERWATER WEIR

4.3 Wide crested weir

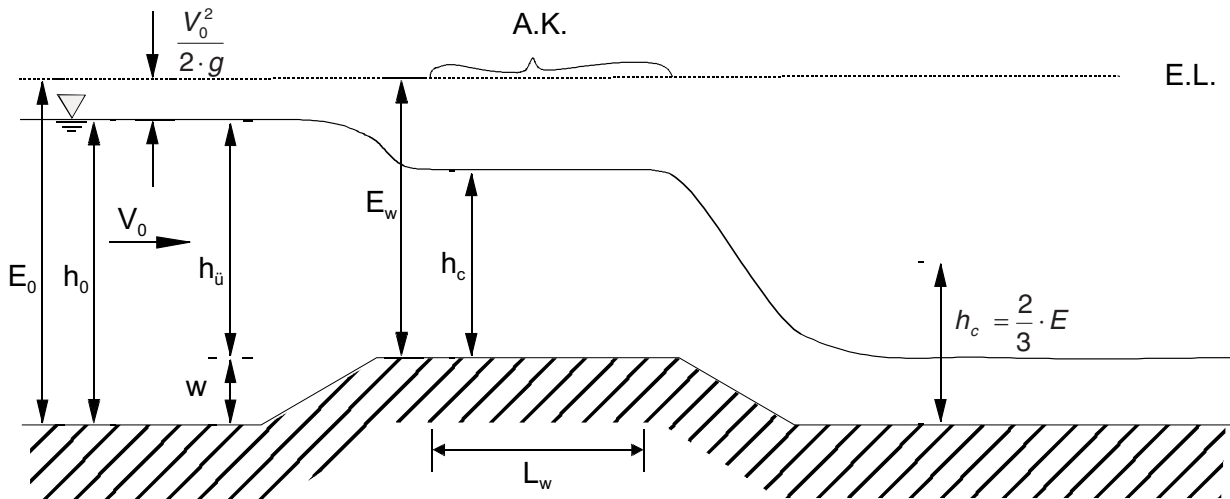

Fig. 4.6 Wide crested weir in rectangular flume with width B

The figure shows a wide crested weir in a flume. This type of weir is not used in modern hydraulic engineering but is important for the theoretical derivation of the flow formula for weirs.

The weir is located in a channel with a constant width B , an approach speed of V_0 , a depth h_0 and the specific energy E_0 . The flow in the area of the weir is almost free of friction, i.e. the energy line is horizontal. The weir line w reduces the specific energy, $E_w = E_0 - w$, over the weir length L_w . The weir is sufficiently long for a parallel flow with hydrostatic pressure distribution to be established. This entire flow area over L_w is thus in the critical flow condition and acts as a “flow control”.

HM 160.38 UNDERWATER WEIR

The critical water depth over the weir is given by equation (13)

$$h_c = \frac{2}{3}E_w = \frac{2}{3}(E_0 - w) = \frac{2}{3}\left(h_{\bar{u}} + \frac{V_0^2}{2g}\right) \quad (17)$$

where $h_{\bar{u}}$ is the water level relative to the height of the weir, i.e. the “damming height”, as a weir always causes a damming effect. The critical flow, from equation (10) or (16), is thus used to calculate the total flow

$$Q = q \cdot B = \sqrt{gh_c^3} B = \sqrt{g} \cdot \left[\frac{2}{3}\left(h_{\bar{u}} + \frac{V_0^2}{2g}\right)\right]^{\frac{3}{2}} \cdot B \quad (18)$$

This equation can be arranged to give

$$Q = \left[\frac{1}{\sqrt{2}}\left(\frac{2}{3}\right)^{\frac{3}{2}}\left(1 + \frac{V_0^2}{2gh_{\bar{u}}}\right)^{\frac{3}{2}}\right] \cdot \sqrt{2gh_{\bar{u}}^{\frac{3}{2}}} \cdot B \quad (19)$$

to maintain the standard type of flow formula for overflowing structures (weirs)

$$Q = C_Q \cdot \sqrt{2 \cdot g} \cdot h_{\bar{u}}^{\left(\frac{3}{2}\right)} \cdot B \quad (20)$$

where C_Q is a flow coefficient with no dimension. For a wide crested weir, C_Q is equal to the expression in brackets in equation (18). The guideline value for a high weir with a significant damming effect, $\frac{h_{\bar{u}}}{w} \rightarrow 0$ and $V_0 \rightarrow 0$ is:

$$C_Q = \frac{1}{\sqrt{2}} \cdot \left(\frac{2}{3}\right)^{\left(\frac{3}{2}\right)} = 0.385 \quad (21)$$

HM 160.38 UNDERWATER WEIR

The weir flow formula, equation (20), is used for general forms of weir, with the flow coefficient being dependent on several factors, e.g.:

$$\frac{h_w}{w}, \text{ relative damming height}$$

$$Fr_0 = \frac{V_0}{\sqrt{gh_0}}, \text{ Froude number of flow}$$

Particularly for weirs with small dimensions, such as those in laboratory models, Reynolds and Weber number effects can also play a role but are otherwise normally negligible.

$$Re = \frac{V_0 h_0}{\nu}, \text{ Reynolds number}$$

$$We = \frac{V_0}{\sqrt{\frac{\sigma}{\rho} h_w}}, \text{ Weber number}$$

HM 160.38 UNDERWATER WEIR
5 Appendix
5.1 Technical data

Material: PE
 Dimensions:
 (L x W x H) 357 x 85 x 30 mm
 Angle of inclination on both sides: 30 °

5.2 Symbols and abbreviations in formulae

A.K.		Flow control
E.L.		Energy line
B	[m]	Flume width
Fr		Froude number
c		Wave speed
C _Q		Flow coefficient
g	[m/s ²]	Acceleration due to gravity
h	[m]	Water depth
h _c	[m]	Critical water depth
E	[m]	Specific energy level in flume flow
L _w	[m]	Weir length
V	[m/s]	Average speed in principal direction of flow
w	[m]	Weir height
We		Weber number
q	[m ² /s]	Flow per unit of width, specific flow
Q	[m ³ /s]	Flow rate
y		Wall co-ordinates (distance)
σ	[N/m ²]	Surface tension
ν	[m ² /s]	Kinematic viscosity
ρ	[kg/m ³]	Density

HM 160.38 *UNDERWATER WEIR*

5.3 References

Lecture script: "Gerinnehydraulik" [Flume hydraulics], by Prof. G.H. Jirka Ph. D., University of Karlsruhe, 3rd May 2003

5.4 Items Supplied

- 1x HM 160.38 underwater weir unit (complete)
- 1x Technical description for HM 160.38 underwater weir